

PFMF342S-32
4-LINE + GROUND SCIF/FACILITY FILTER

SPECIFICATIONS

- MAX VOLTAGE: 0-277/0-480VAC
- MAX CURRENT/LINE: 32A
- FREQUENCY: 50/60HZ
- OPERATING TEMP.: -40 TO 65C
- HIPOT(LINE-GROUND): 2200VDC
- DISCHARGE VOLT. (@277V): <30V IN 30S
- VOLT. DROP: <2% AT FULL RATED UNITY LOAD
- OVERLOAD: 140% OF RATED CURRENT FOR 15 MINUTES
- PERFORMANCE: 100dB (14KHZ TO 40GHZ)
- MANUFACTURED IN ACCORDANCE WITH THE

FOLLOWING STANDARDS:

- MIL-STD-220
- MI-F-15733
- MIL-STD-810
- LV DIRECTIVE



CONFORMS TO
 UL STD 1283

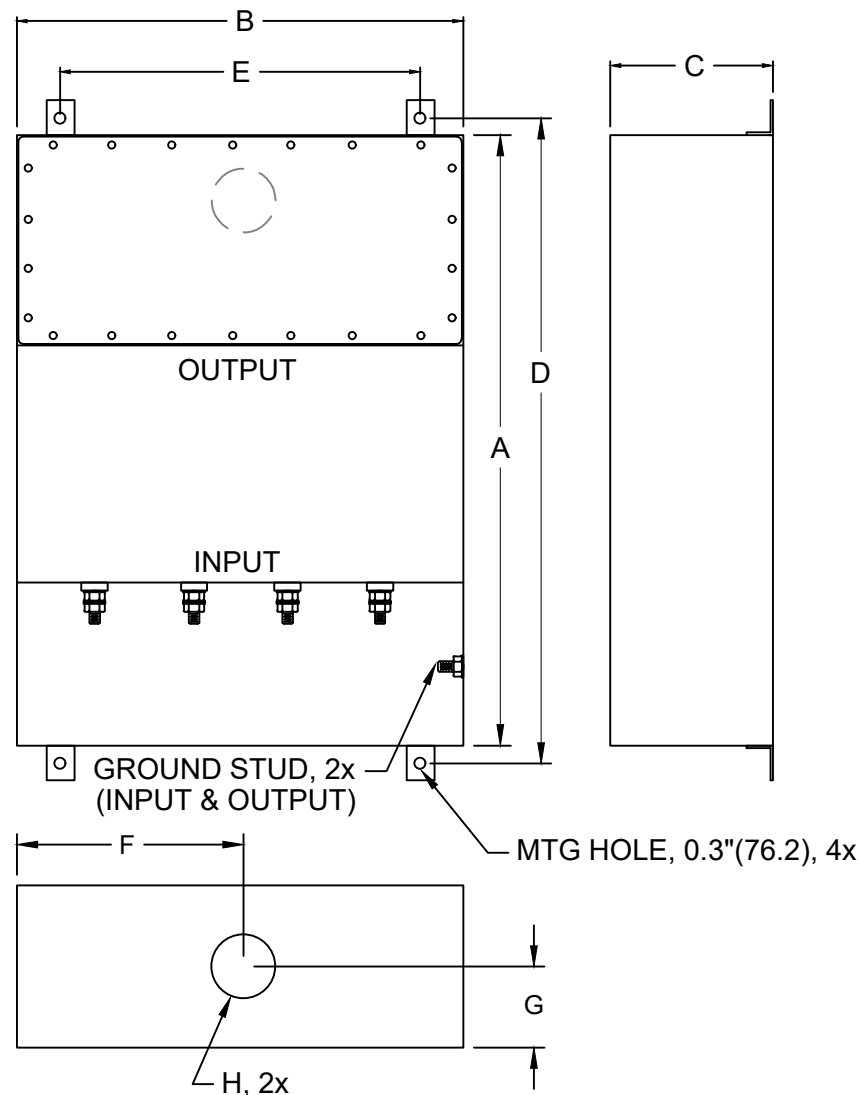

(FOR DIFFERENT CUTOUT SIZES OR LOCATIONS, CONSULT FACTORY)

MODEL	AMPS	TERMINAL	DIMENSIONS (MM)								WEIGHT LBS(KG)
			A	B	C	D	E	F	G	H	
PFMF342S-32	32	M6	610	381	127	648	331	191	63	35	58 (26.4)
			(24)	(15)	(5)	(25.5)	(13)	(7.5)	(2.5)	(1.38)	