

PFMT255S-16
2-LINE + GND TEMPEST FILTER
INPUT/OUTPUT EMI COMPARTMENTS

SPECIFICATIONS

MAX VOLTAGE: 0-277/0-480VAC

MAX CURRENT: 16A/LINE

FREQUENCY: 50/60HZ

OPERATING TEMP.: -40 TO 70C

HIPOT (L-G): 2200VDC

(PRIOR TO INSTALLING DISCHARGE RESISTORS)

DISCHARGE VOLT. (@277V): <30V IN 30S

OVERLOAD: 140% RATED CURRENT FOR 15 MINUTES

PERFORMANCE: >100dB (10KHZ TO 40GHZ)

MANUFACTURED IN ACCORDANCE WITH

THE FOLLOWING STANDARDS:

MIL-STD-220

MIL-F-15733

MIL-STD-810

LV DIRECTIVE



Intertek
5025116

CONFORMS TO
UL STD 1283

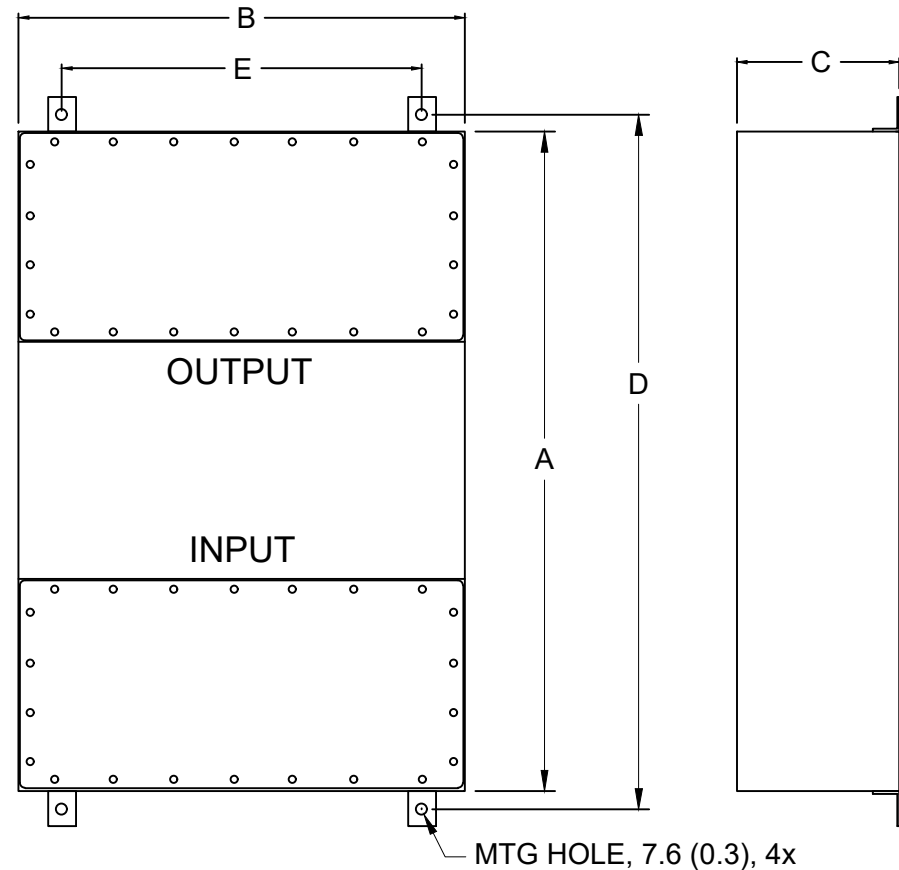

MODEL	AMPS	TERMINALS	DIMENSIONS - MM(IN)					WEIGHT LBS(KG)
			A	B	C	D	E	
PFMT255S-16	16	M6	432	178	102	472	127	16 (7.3)
			(17)	(7)	(4)	(18.6)	(5)	