

PF215S-30-10

1PH COMMERCIAL/INDUSTRIAL FILTER  
DUAL STAGE / CHASSIS MOUNT

## SPECIFICATIONS

MAX VOLTAGE: 0-300VAC  
 MAX CURRENT: 30A/LINE  
 USABLE FREQUENCY: 50/60/400HZ  
 OPERATING TEMP.: -40 TO 50C  
 LEAKAGE CURRENT (250V/60HZ): <1mA  
 TYP. WEIGHT, LB(KG): 0.9(0.41)  
 CLIMATIC CLASS: 25/100/21  
 DESIGNED AND MANUFACTURED IN ACCORDANCE  
 WITH THE FOLLOWING STANDARDS:  
 EN60939-3  
 CSA22.2 NO. 8  
 LV DIRECTIVE

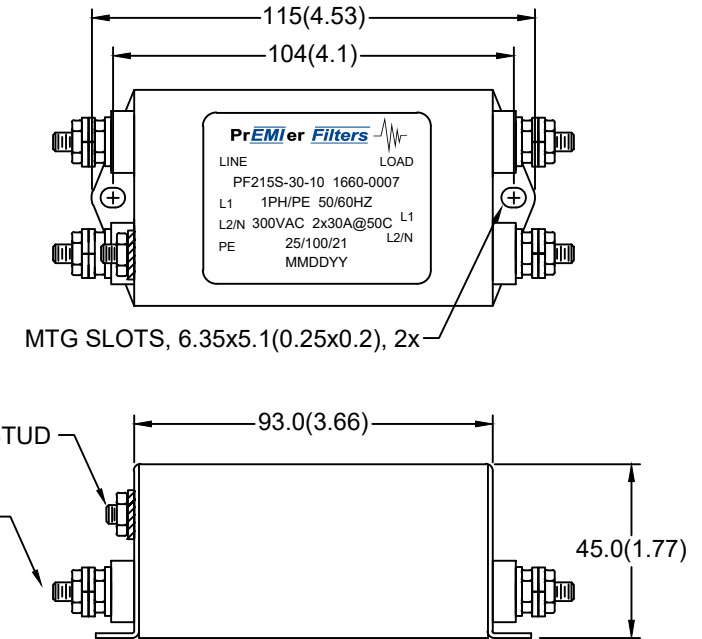
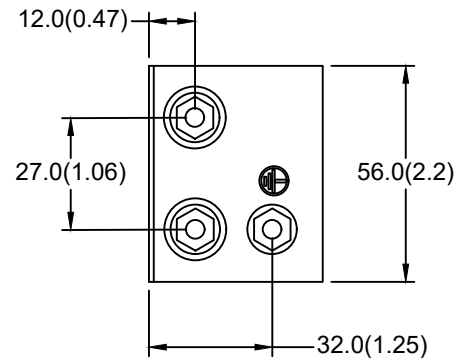

## SCHEMATIC

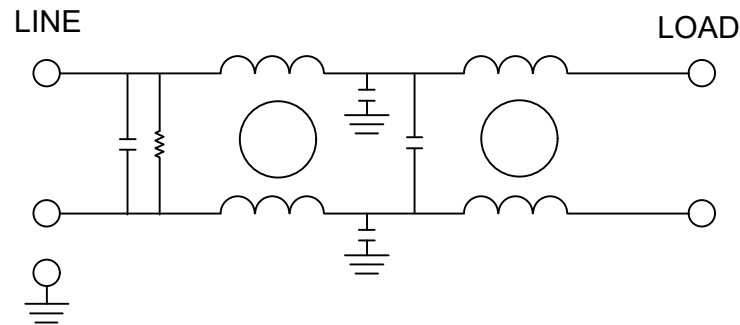

TYPICAL INSERTION LOSS, 50/50 OHM					
FREQ(HZ)	150K	500K	1M	10M	30M
CM, dB	66	72	70	56	52
DM, dB	56	62	68	60	61