

PF220S-30-10

1PH COMMERCIAL/INDUSTRIAL FILTER
DUAL STAGE / CHASSIS MOUNT

SPECIFICATIONS

MAX VOLTAGE: 0-300VAC
 MAX CURRENT: 30A/LINE
 USABLE FREQUENCY: 50/60/400HZ
 OPERATING TEMP.: -40 TO 50C
 LEAKAGE CURRENT (250V/60HZ): <1mA
 TYP. WEIGHT, LB(KG): 2.5(1.14)
 CLIMATIC CLASS: 25/100/21
 DESIGNED AND MANUFACTURED IN ACCORDANCE
 WITH THE FOLLOWING STANDARDS:
 EN60939-3
 CSA22.2 NO. 8
 LV DIRECTIVE

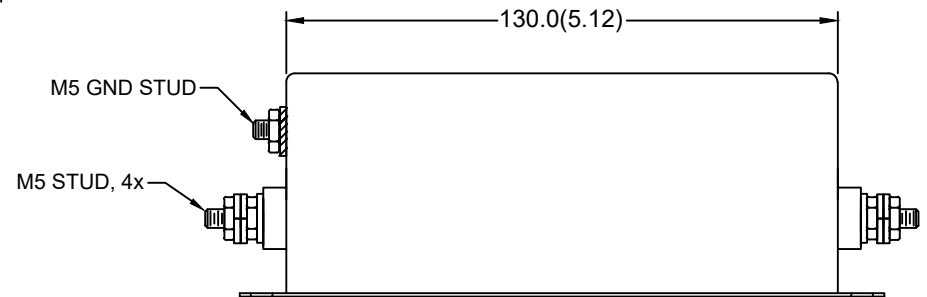
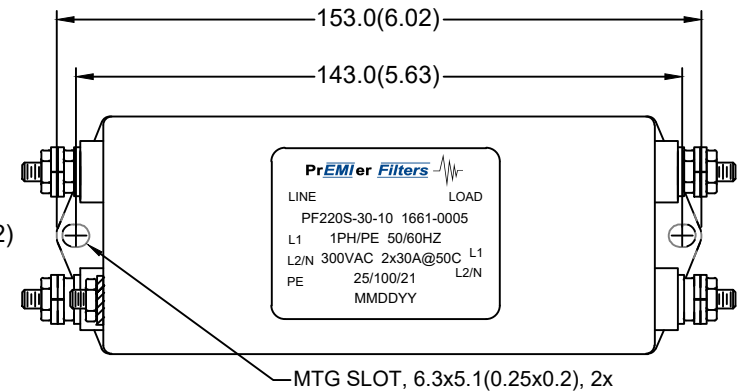
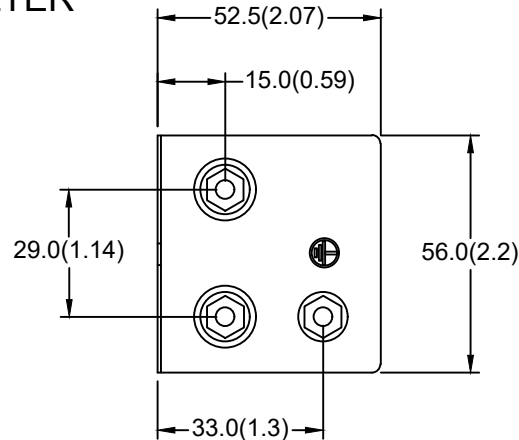

SCHEMATIC

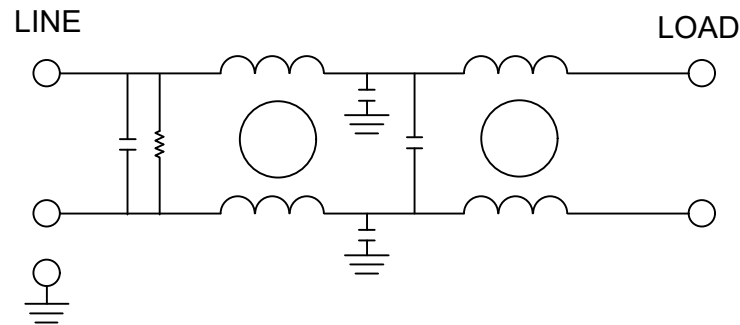

TYPICAL INSERTION LOSS, 50/50 OHM					
FREQ(HZ)	150K	500K	1M	10M	30M
CM, dB	70	74	70	60	52
DM, dB	64	66	70	62	60