

PF220S-6-10

1PH COMMERCIAL/INDUSTRIAL FILTER
DUAL STAGE / CHASSIS MOUNT

SPECIFICATIONS

- MAX VOLTAGE: 0-300VAC
- MAX CURRENT: 6A/LINE
- USABLE FREQUENCY: 50/60/400HZ
- OPERATING TEMP.: -40 TO 50C
- LEAKAGE CURRENT (250V/60HZ): <1mA
- TYP. WEIGHT, LB(KG): 2.5(1.14)
- CLIMATIC CLASS: 25/100/21
- DESIGNED AND MANUFACTURED IN ACCORDANCE WITH THE FOLLOWING STANDARDS:

 - EN60939-3
 - CSA22.2 NO. 8
 - LV DIRECTIVE

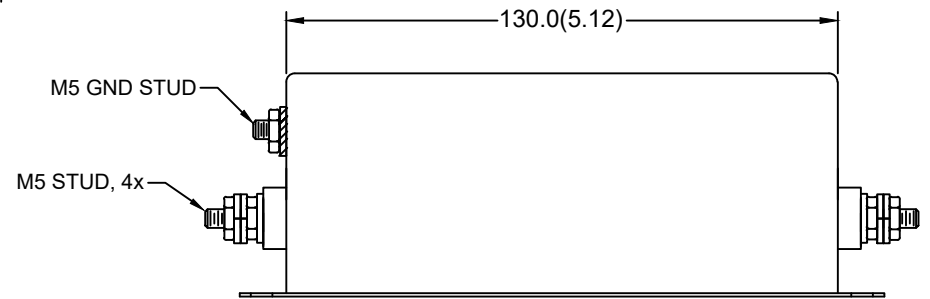
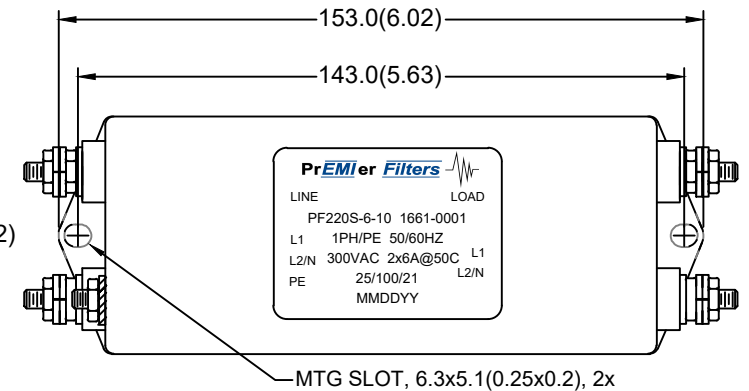
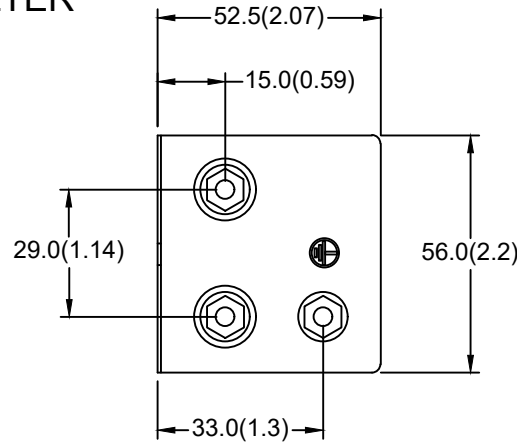

SCHEMATIC

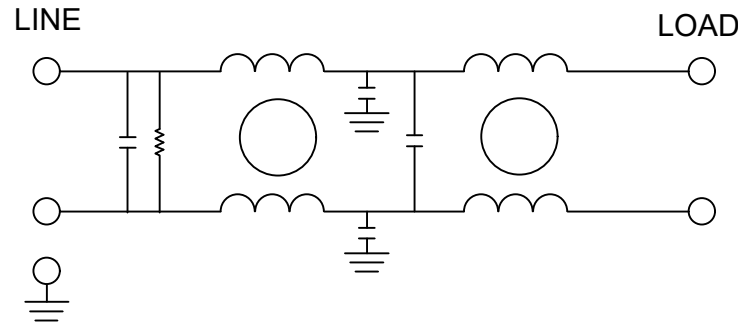

TYPICAL INSERTION LOSS, 50/50 OHM					
FREQ(HZ)	150K	500K	1M	10M	30M
CM, dB	70	74	70	60	52
DM, dB	64	66	70	62	60