

PF355S-60-1000

3PH DELTA COMMERCIAL/INDUSTRIAL FILTER
DUAL STAGE / CHASSIS MOUNT

SPECIFICATIONS

- MAX VOLTAGE: 0-520VAC
- MAX CURRENT: 60A/LINE
- USABLE FREQUENCY: 50/60/400HZ
- OPERATING TEMP.: -40 TO 50C
- LEAKAGE CURRENT (250V/60HZ): <3.5mA
- TYP. WEIGHT, LB(KG): 14.0(6.36)
- CLIMATIC CLASS: 25/100/21
- DESIGNED AND MANUFACTURED IN ACCORDANCE WITH THE FOLLOWING STANDARDS:
 - EN60939-3
 - CSA22.2 NO. 8
 - LV DIRECTIVE

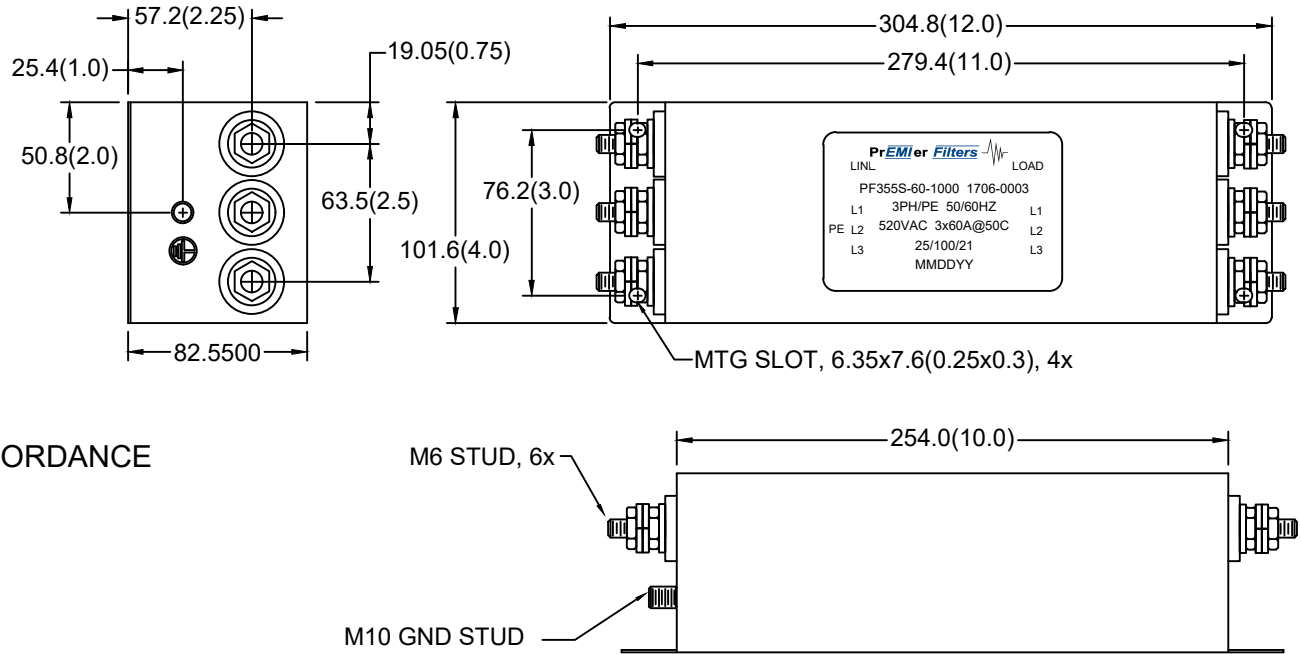

SCHMATIC

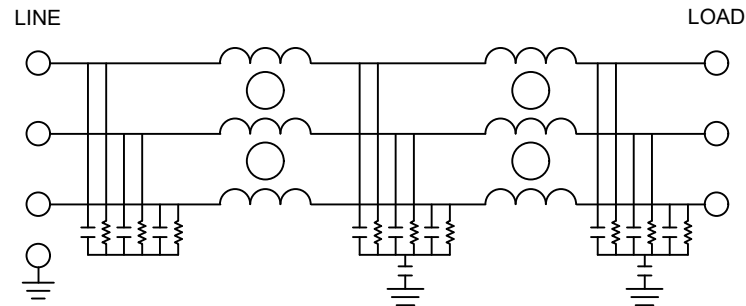

TYPICAL INSERTION LOSS, 50/50 OHM					
FREQ(HZ)	150K	500K	1M	10M	30M
CM, dB	72	76	74	70	40
DM, dB	66	74	76	70	40