

PF403S-20-100

3PH WYE COMMERCIAL/INDUSTRIAL FILTER
SINGLE STAGE / CHASSIS MOUNT

SPECIFICATIONS

- MAX VOLTAGE: 0-520VAC
- MAX CURRENT: 20A/LINE
- USABLE FREQUENCY: 50/60/400HZ
- OPERATING TEMP.: -40 TO 50C
- LEAKAGE CURRENT (250V/60HZ): <1mA
- TYP. WEIGHT, LB(KG): 3.8(1.7)
- CLIMATIC CLASS: 25/100/21
- DESIGNED AND MANUFACTURED IN ACCORDANCE

WITH THE FOLLOWING STANDARDS:

- EN60939-3
- CSA22.2 NO. 8
- LV DIRECTIVE

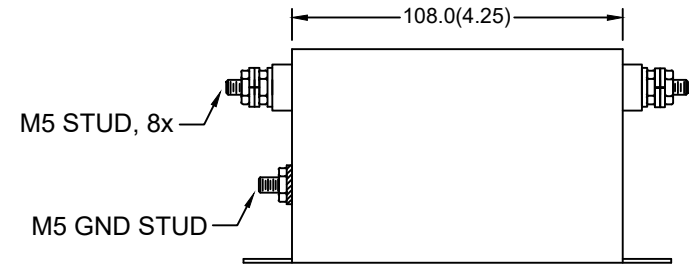
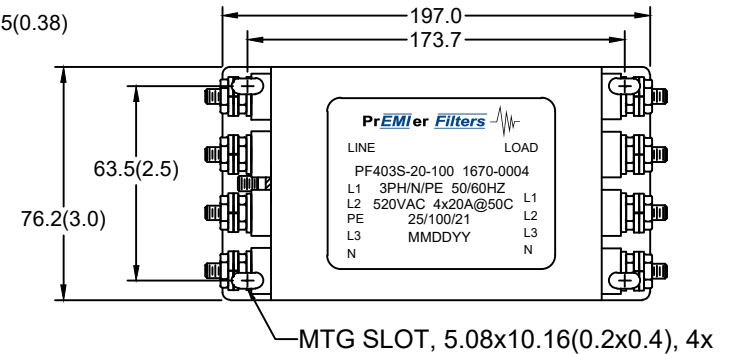
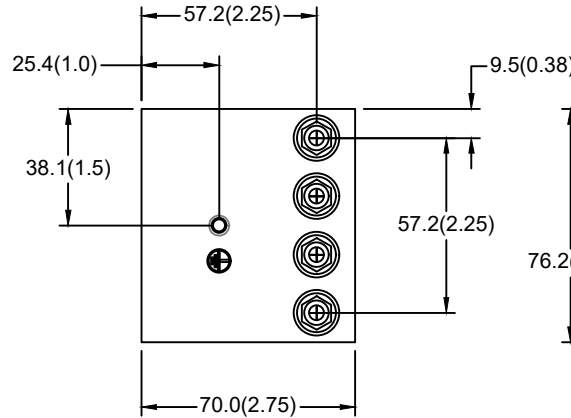

SCHEMATIC

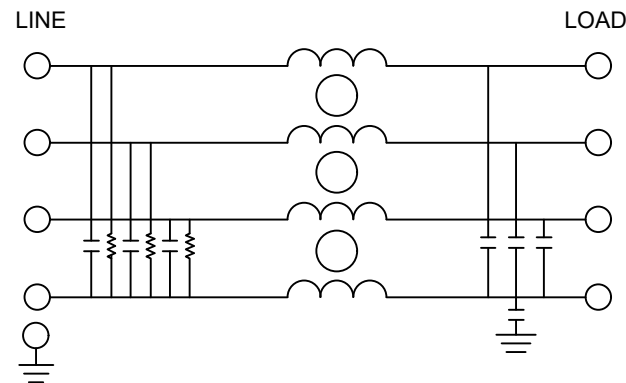

TYPICAL INSERTION LOSS, 50/50 OHM					
FREQ(HZ)	150K	500K	1M	10M	30M
CM, dB	48	56	62	50	40
DM, dB	46	70	72	66	50