



PFM85S-20-22

1PH MILITARY FILTER

(E.G. MIL-STD-461, DO-160, ETC.)

**SPECIFICATIONS**

MAX VOLTAGE: 0-300VAC

MAX CURRENT: 20A/LINE

FREQUENCY: 50/60/400HZ

OPERATING TEMP.: -40 TO 70C

HI POT (L-G): 1800VDC

LEAKAGE CURRENT(@250V/60HZ): <3.5mA

TYP. WEIGHT, LB(KG): 2.8(1.27)

MANUFACTURED IN ACCORDANCE WITH

THE FOLLOWING STANDARDS:

UL1283

MIL-STD-220

MIL-F-15733

LV DIRECTIVE

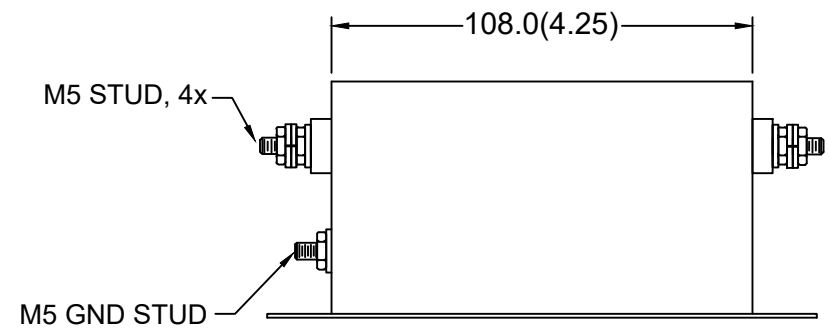
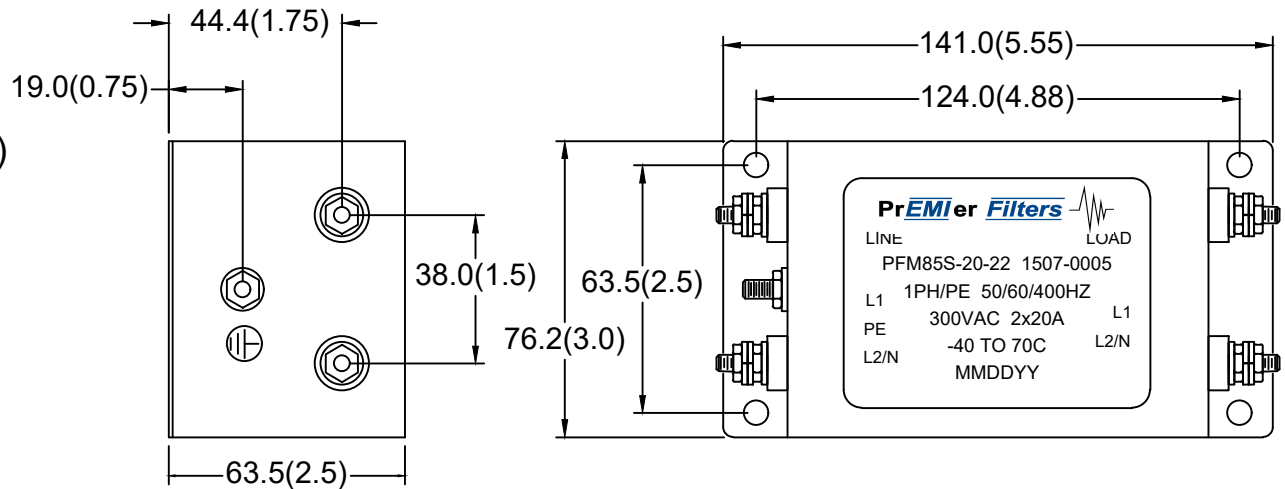

TYPICAL INSERTION LOSS, 50/50 OHM					
FREQ(HZ)	10K	100K	500K	1M	10M
CM,dB	24	40	59	55	51
DM, dB	28	48	60	62	45