

PFMT355S-32

**3-LINE + GND TEMPEST FILTER
INPUT/OUTPUT EMI COMPARTMENTS**

SPECIFICATIONS

MAX VOLTAGE: 0-277/0-480VAC

MAX CURRENT: 32A/LINE

FREQUENCY: 50/60HZ

OPERATING TEMP.: -40 TO 70C

HIPOT (L-G): 2200VDC

(PRIOR TO INSTALLING DISCHARGE RESISTORS)

DISCHARGE VOLT. (@277V): <30V IN 30S

OVERLOAD: 140% RATED CURRENT FOR 15 MINUTES

PERFORMANCE: >100dB (10KHZ TO 40GHZ)

MANUFACTURED IN ACCORDANCE WITH

THE FOLLOWING STANDARDS:

MIL-STD-220

MIL-F-15733

MIL-STD-810

LV DIRECTIVE



CONFORMS TO
UL STD 1283

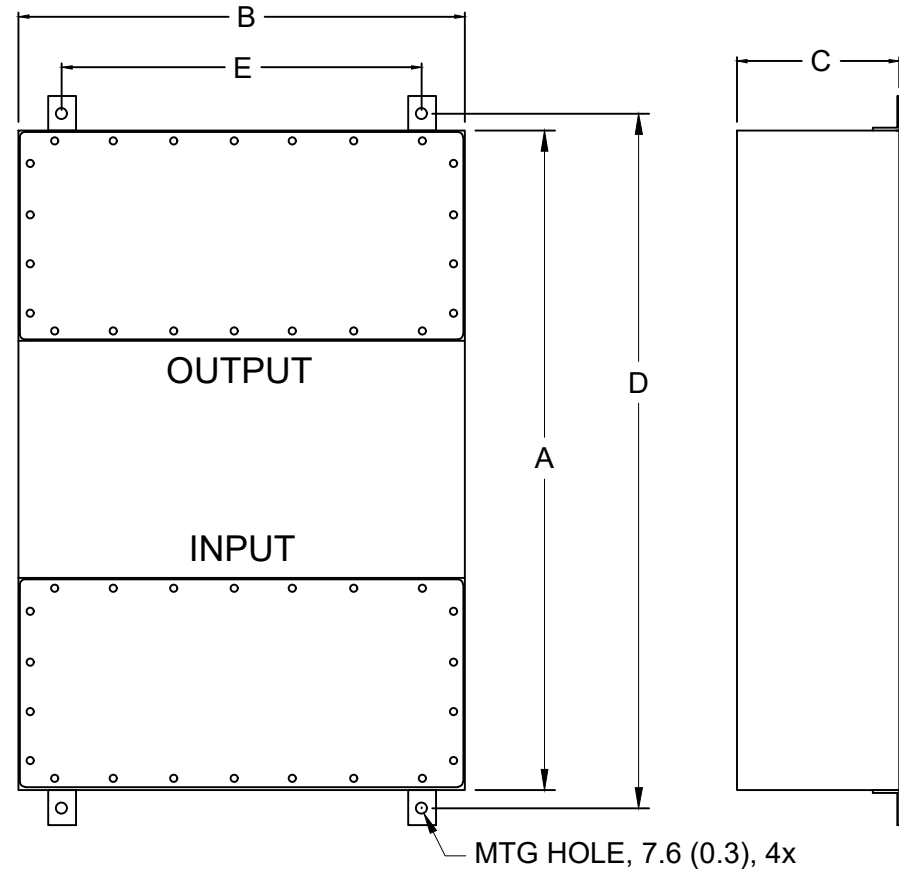

MODEL	AMPS	TERMINALS	DIMENSIONS - MM (IN)					WEIGHT LBS(KG)
			A	B	C	D	E	
PFMT355S-32	32	M6	457 (18)	229 (9)	127 (5)	497 (19.6)	178 (7)	36(16.4)