

PFMT455S-63

**4-LINE + GND TEMPEST FILTER
INPUT/OUTPUT EMI COMPARTMENTS**

SPECIFICATIONS

MAX VOLTAGE: 0-277/0-480VAC

MAX CURRENT: 63A/LINE

FREQUENCY: 50/60HZ

OPERATING TEMP.: -40 TO 70C

HIPOT (L-G): 2200VDC

(PRIOR TO INSTALLING DISCHARGE RESISTORS)

DISCHARGE VOLT. (@277V): <30V IN 30S

OVERLOAD: 140% RATED CURRENT FOR 15 MINUTES

PERFORMANCE: >100dB (10KHZ TO 40GHZ)

MANUFACTURED IN ACCORDANCE WITH
THE FOLLOWING STANDARDS:

MIL-STD-220

MIL-F-15733

MIL-STD-810

LV DIRECTIVE



CONFORMS TO
UL STD 1283

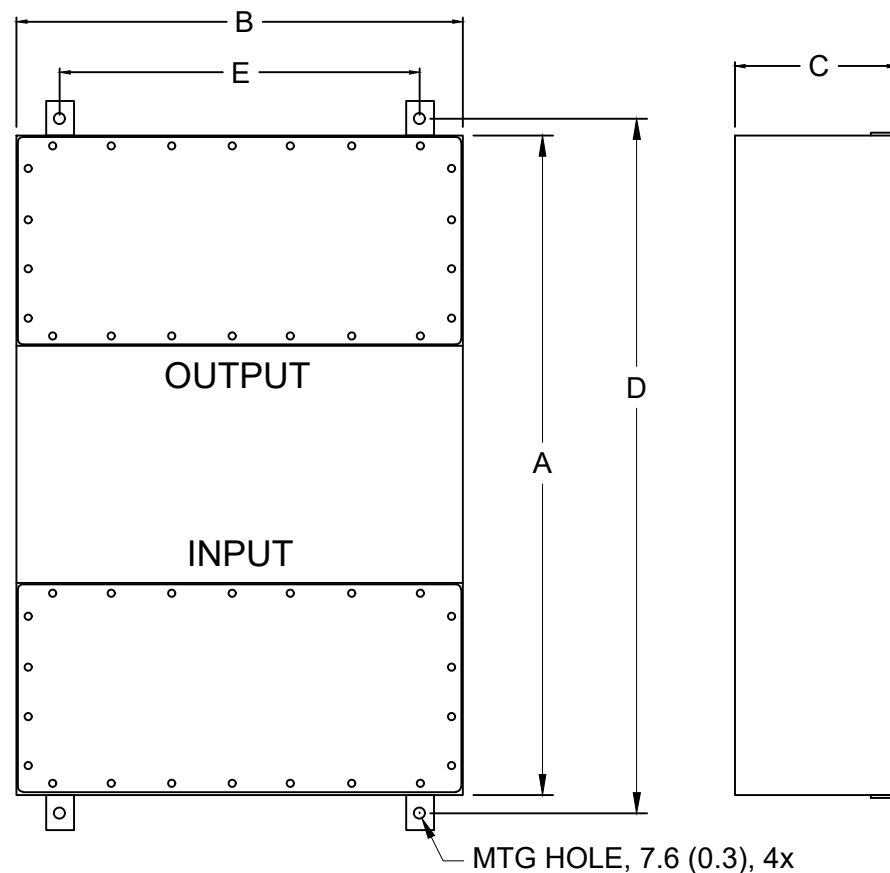

MODEL	AMPS	TERMINALS	DIMENSIONS - MM (IN)					WEIGHT LBS(KG)
			A	B	C	D	E	
PFMT455S-63	63	M6	559 (22)	355 (14)	140 (5.5)	599 (23.6)	305 (12)	82(37.3)